

*Artisan*TM
USA



**SIDE BURNER GAS
SUPPLY CONVERSION**

TOOLS REQUIRED TO INSTALL THIS KIT:

ITEM	DESCRIPTION:
A	SCREWDRIVER - FLAT 1/8" WIDE TIP
B	RATCHETING SOCKET WRENCH
C	SOCKET EXTENSION DRIVER - 3" (MINIMUM)
D	10 mm SOCKET

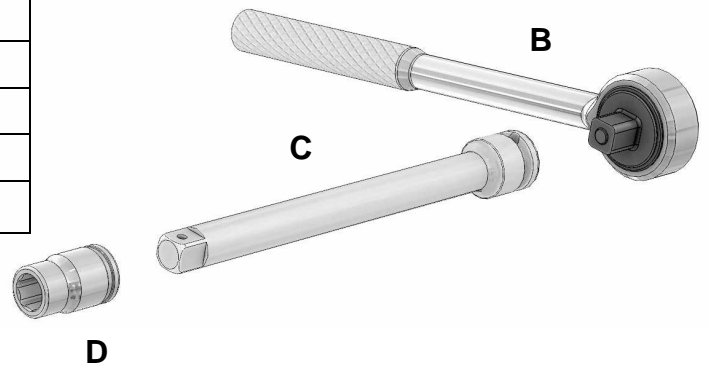
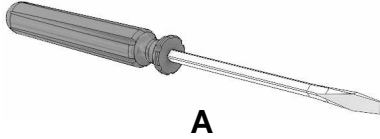

REPLACEMENT PROCEDURE:

STEP 1:

Remove the Top Grate, Outside and Inner Burner Caps to expose the orifice by lifting them straight up from the unit.

STEP 2:

Using the 10 mm socket with the extension driver and wrench, remove the orifice located at the bottom of the cone-shaped burner body.

STEP 3:

Replace the existing orifice with the proper fuel-type orifice for your application. **DO NOT OVERTIGHTEN!**

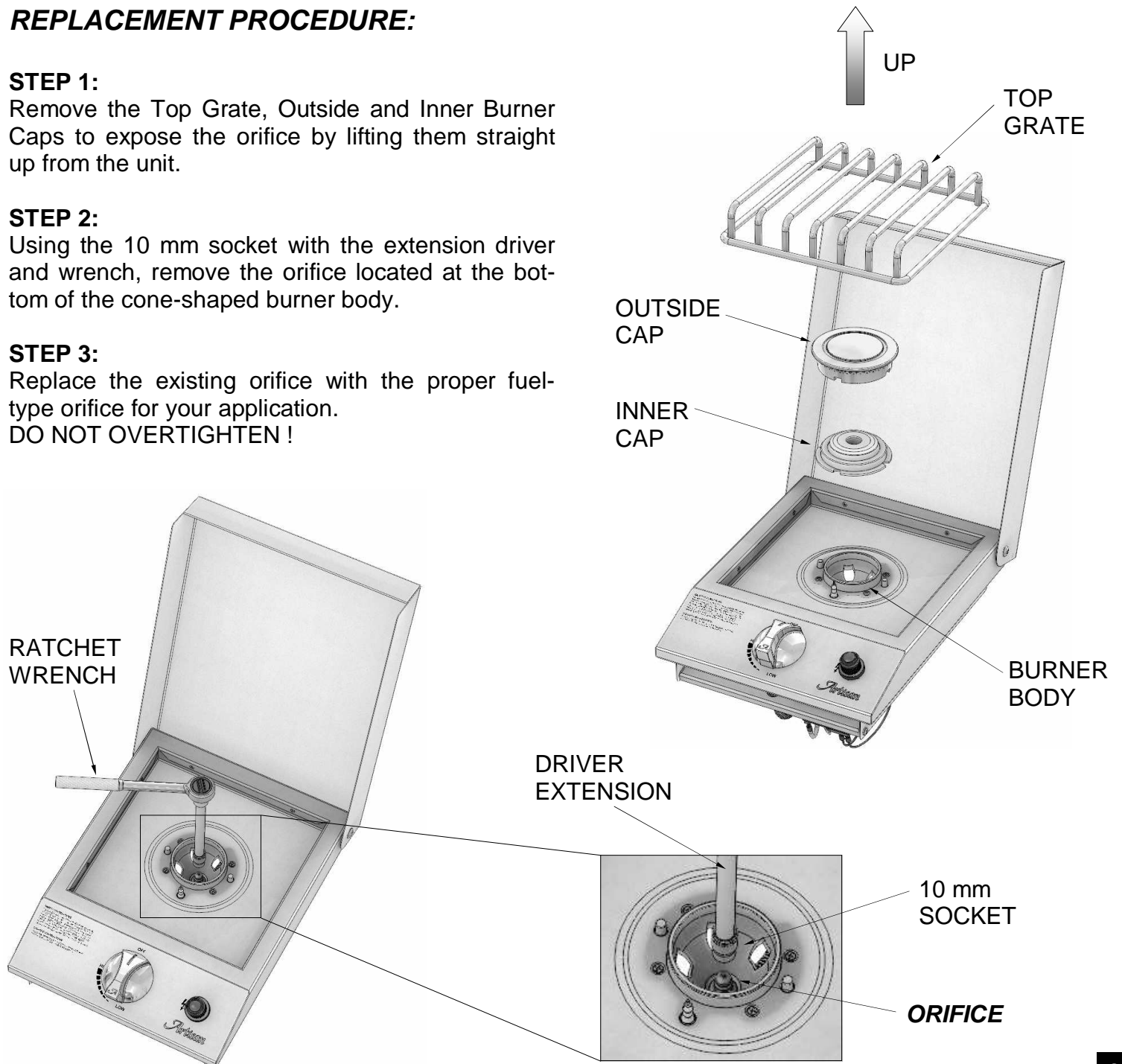

LOW HEAT SETTING ADJUSTMENT:

NOTE:

THE LOW HEAT SETTING ON YOUR SIDE BURNER IS PRESET AT THE FACTORY FOR THE FUEL IT WAS DESIGNED TO WORK WITH.

ADJUST THE LOW HEAT SETTING WHEN CHANGING FUELS OR WHEN ALTITUDE OR OTHER ENVIRONMENTAL FACTORS ARE CAUSING POOR, LOW HEAT, PERFORMANCE.

WARNING

NEVER ADJUST THE BURNER SO LOW THAT IT MAY GO OUT DURING USE. DO NOT OPERATE THE SIDE BURNER WITH THE LOW HEAT SCREW REMOVED.

GAS CAN ESCAPE AND CAUSE A POTENTIALLY HAZARDOUS CONDITION.

ADJUSTMENT STEPS:

1. Follow lighting instructions by setting the control knob on "HI" and allow the burner to preheat for 10 minutes.
2. Turn the control knob to "LOW" and wait for the burner temperature to drop and stabilize.
3. **Attempting adjustment at any setting other than LOW can create a dangerous condition.**
4. Remove knob by pulling straight away from control panel.
5. Insert a small blade (1/8" wide) screwdriver into the valve stem to begin the adjustment.
6. Turn counter-clockwise to INCREASE the low heat flame, or clockwise to DECREASE the flame height. (see figure at right).

1/8" FLAT SCREWDRIVER

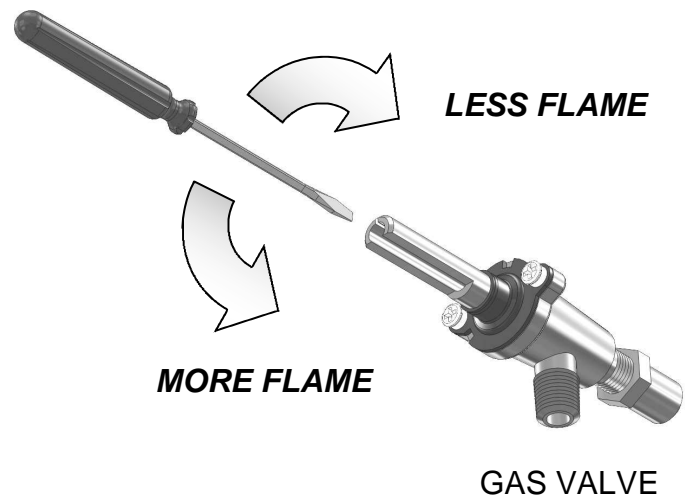

Adjust the flames so the burner is fully lit around the perimeter when the knob is in the LOW position. Do not adjust the burner flame so low that it may go out during use. Once proper adjustment is reached, reattach the knob by pushing onto stem.

Your *Artisan*[™] Side Burner is now ready for use with the new fuel.

GAS CONVERSION KIT NUMBER

MODEL:	NG ◀▶ LP
ART-SB1	190-0043

CONVERTION KIT FOR ART-SB1 SIDE BURNER FROM NG TO LP FUEL OR VICE VERSA

FRONT VIEW

SIDE VIEW

ISO VIEW

ITEM:

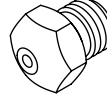
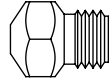

**SIDE BURNER ORIFICE
SIZE: 46 GA. (NG)**

**PART#: 220-0368
QTY: 1**

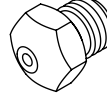
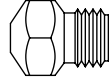

**SIDE BURNER ORIFICE
SIZE: 55 GA. (LP)**

**PART#: 220-0369
QTY: 1**

Artisan[™] Side Burner Gas Supply
Conversion Instructions
Artisan[™] USA Grills
All Rights Reserved • 09/2011